

# VARiON<sup>®</sup> *Plus* 700 IQ H

MODULAR SENSOR FOR AMMONIUM AND NITRATE  
FOR CLASS I DIVISION 2 APPLICATIONS



a xylem brand



For the most recent version of the manual, please visit [www.ysi.com](http://www.ysi.com).

**Contact**

YSI  
1725 Brannum Lane  
Yellow Springs, OH 45387 USA  
Tel: +1 937-767-7241  
800-765-4974  
Email: [info@ysi.com](mailto:info@ysi.com)  
Internet: [www.ysi.com](http://www.ysi.com)

**Copyright**

© 2020 Xylem Inc.

# VARiON<sup>®Plus</sup> 700 IQ H - Contents

<b>1</b>	<b>Overview</b>	<b>5</b>
1.1	How to use this component operating manual	5
1.2	Structure of the sensor VARiON <sup>®Plus</sup> 700 IQ H	6
1.3	Recommended fields of application	8
<b>2</b>	<b>Safety</b>	<b>9</b>
2.1	Safety information	9
2.1.1	Hazard warnings in this operating manual	9
2.1.2	Safety information on the product	9
2.1.3	Further documents providing safety information	9
2.2	Safe operation	10
2.2.1	Authorized use	10
2.2.2	Requirements for safe operation	10
2.2.3	Unauthorized use	10
2.3	Hazardous location use	11
<b>3</b>	<b>Commissioning</b>	<b>12</b>
3.1	Scopes of delivery	12
3.2	Notes on the handling of the electrodes	12
3.2.1	Effects to be generally avoided	12
3.2.2	Reference electrode	13
3.2.3	Measurement electrodes and compensation electrodes	14
3.3	Getting the sensor ready for measuring	15
3.3.1	Equipping the sensor with electrodes	15
3.3.2	Mounting the protective hood	16
3.3.3	Connecting the sensor to the IQ SENSORNET	18
3.4	Settings	20
3.4.1	General information	20
3.4.2	Setting table VARiON A (ammonium sensor)	21
3.4.3	Setting table VARiON N (nitrate sensor)	23
3.4.4	Setting table VARiON K (potassium sensor)	26
3.4.5	Setting table VARiON Cl (chloride sensor)	27
<b>4</b>	<b>Matrix adjustment, check and calibration</b>	<b>29</b>
4.1	General information	29
4.2	Matrix adjustment	30
4.2.1	General information on matrix adjustment	30
4.2.2	Carrying out the matrix adjustment	30
4.2.3	Result of the matrix adjustment	31
4.2.4	Special functions	32
4.3	Check and calibration in standard solutions	32
4.3.1	General information on checking and calibrating	32
4.3.2	Result of the check	34

---

4.3.3	Result of the calibration .....	34
4.4	Sensor history .....	35
<b>5</b>	<b>Measuring .....</b>	<b>38</b>
5.1	Measurement operation .....	38
5.2	Factors affecting the measured value .....	38
<b>6</b>	<b>Maintenance and electrode exchange .....</b>	<b>39</b>
6.1	General maintenance instructions .....	39
6.2	Exterior cleaning .....	39
6.3	Exchanging the electrodes .....	42
6.4	Polishing the chloride electrode .....	43
<b>7</b>	<b>Replacement parts and accessories .....</b>	<b>44</b>
7.1	Electrodes .....	44
7.2	General accessories .....	44
<b>8</b>	<b>What to do if ... ..</b>	<b>46</b>
8.1	Interpretation of the drift voltage .....	46
8.2	Error causes and remedies .....	47
<b>9</b>	<b>Technical data .....</b>	<b>50</b>
9.1	Measuring characteristics .....	50
9.2	Application conditions .....	52
9.3	General data .....	52
9.4	Instrument safety .....	54
9.4.1	General instrument safety .....	54
9.4.2	Hazardous location ratings .....	54
9.5	Electrical data .....	54
9.6	Data of the VARiON <sup>®Plus</sup> electrodes .....	55
9.6.1	Response times .....	55
9.6.2	Materials .....	55
9.6.3	Weights .....	55
<b>10</b>	<b>Indexes .....</b>	<b>56</b>
10.1	Explanation of the messages .....	56
10.1.1	Error messages .....	56
10.1.2	Informative messages .....	57
10.2	Status info .....	58
<b>11</b>	<b>Contact Information .....</b>	<b>59</b>
11.1	Ordering & Technical Support .....	59
11.2	Service Information .....	59

# 1 Overview

## 1.1 How to use this component operating manual

### Structure of the IQ SENSORNET operating manual

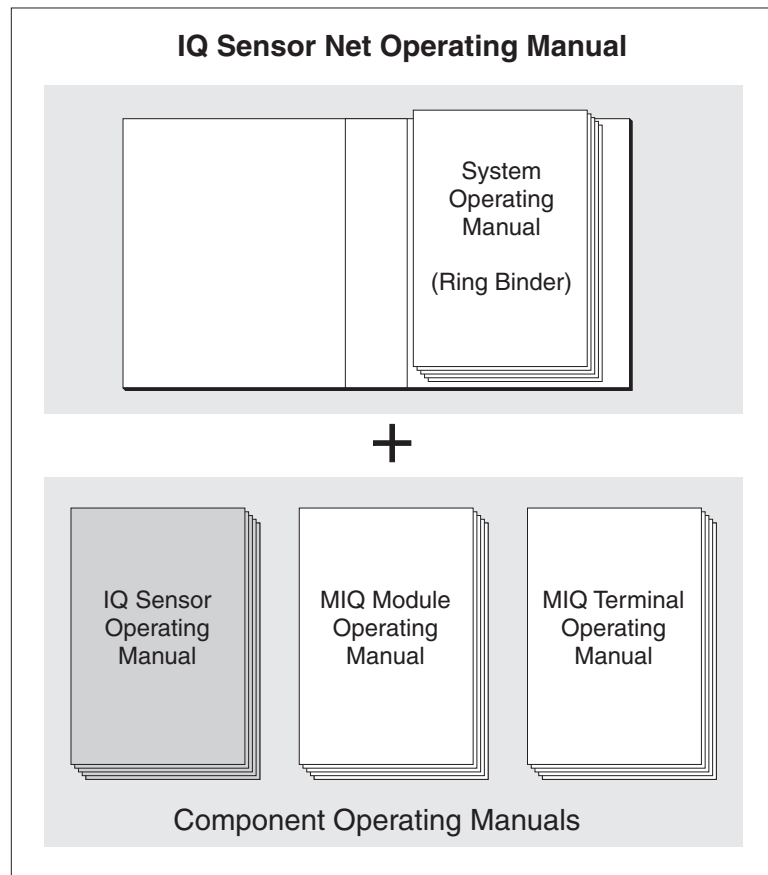

Fig. 1-1 Structure of the IQ SENSORNET operating manual

The IQ SENSORNET operating manual has a modular structure like the IQ SENSORNET itself. It consists of a system operating manual and the operating manuals of all the components used.

Please file this component operating manual in the ring binder of the system operating manual.

## 1.2 Structure of the sensor VARiON<sup>®Plus</sup> 700 IQ H

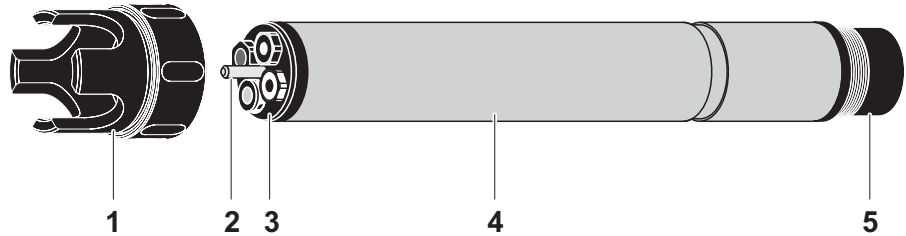

Fig. 1-2 Structure of the sensor VARiON<sup>®Plus</sup> 700 IQ H

1	Protective hood
2	Temperature sensor
3	Electrode support with electrodes (sample equipment)
4	Sensor shaft
5	Plug head connector

### Electrodes

For a VARiON<sup>®Plus</sup> 700 IQ H sensor ready to measure, a jointly used reference electrode and at least one ion sensitive electrode for the main measured parameters (ammonium, nitrate) are required. The electrodes are screwed into the electrode support. The electrode support has four receptacles for this.

### Automatic interfering ions compensation

The VARiON<sup>®Plus</sup> 700 IQ H enables the automatic interfering ions compensation for one main measured parameter. Thus the influence of interfering ions due to measuring technique can be automatically compensated for.

Interfering ions in water / waste water applications are mostly chloride for nitrate measurement and potassium for ammonium measurement. To determine the interfering ions concentration, another electrode (compensation electrode) is mounted into a free receptacle.

If interfering ions concentrations should be dynamically compensated for both main parameters (ammonium, nitrate), the interfering ions concentration measured by another sensor can be used with the *Link (sensor to sensor)* function (see IQ SENSORNET system operating manual).



Information on the fundamentals of measuring with ion sensitive electrodes is given in the primer, ION SELECTIVE MEASUREMENT IN ONLINE ANALYSIS.

**Operating modes and electrode equipment**

Due to its modular structure, the VARiON<sup>®Plus</sup> 700 IQ H can be adapted to various requirements (see table on the following page).

Notes on the table:

The reference electrode has an extra receptacle marked by a recess. The ion sensitive electrodes can be mounted in the remaining three receptacles in any order. Empty receptacles have to be closed with the VARiON<sup>®</sup> BP blind plug.

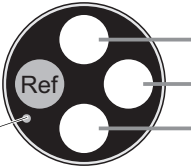
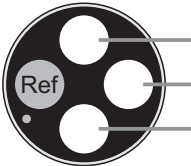
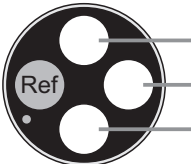
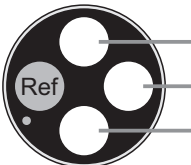
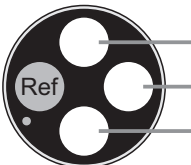
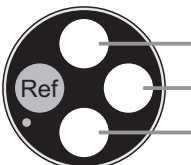
Operating mode	Electrode equipment
Ammonium measurement, compensated	 <p>VARiON<sup>®Plus</sup> Ref (recess)</p> <p>VARiON<sup>®Plus</sup> NH4</p> <p>VARiON<sup>®Plus</sup> K</p> <p>Blind plug</p>
Nitrate measurement, compensated,	 <p>VARiON<sup>®Plus</sup> Ref</p> <p>VARiON<sup>®Plus</sup> NO3</p> <p>VARiON<sup>®Plus</sup> Cl</p> <p>Blind plug</p>
Ammonium measurement, compensated, plus nitrate measurement	 <p>VARiON<sup>®Plus</sup> Ref</p> <p>VARiON<sup>®Plus</sup> NH4</p> <p>VARiON<sup>®Plus</sup> K</p> <p>VARiON<sup>®Plus</sup> NO3</p>
Nitrate measurement, compensated, plus ammonium measurement	 <p>VARiON<sup>®Plus</sup> Ref</p> <p>VARiON<sup>®Plus</sup> NO3</p> <p>VARiON<sup>®Plus</sup> Cl</p> <p>VARiON<sup>®Plus</sup> NH4</p>
Ammonium measurement	 <p>VARiON<sup>®Plus</sup> Ref</p> <p>VARiON<sup>®Plus</sup> NH4</p> <p>Blind plug</p> <p>Blind plug</p>
Nitrate measurement	 <p>VARiON<sup>®Plus</sup> Ref</p> <p>VARiON<sup>®Plus</sup> NO3</p> <p>Blind plug</p> <p>Blind plug</p>

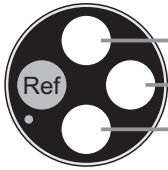
Operating mode	Electrode equipment
Ammonium measurement, nitrate measurement	

**Calibration free operation**

The VARiON<sup>®Plus</sup> 700 IQ H sensor is immediately ready to measure after being equipped with electrodes. For precise measurements, it is only necessary to adjust the electrodes to the sample matrix ("matrix adjustment"). In the recommended application (see section 1.3 RECOMMENDED FIELDS OF APPLICATION), the measuring characteristics of the electrodes remain stable for their entire service life. Thus, calibration is not recommended.

Possible changes of the sample matrix can be determined by occasional comparison measurements (e.g. photometer) and compensated for by a new matrix adjustment as necessary. The sensor does not have to be taken out of the sample for this.

**Shielding of the VARiON<sup>®Plus</sup> 700 IQ H**

The VARiON<sup>®Plus</sup> 700 IQ H sensor and the corresponding electrodes in conjunction with the IQ SENSORNET system form a measuring system that is protected to a high degree against low and high frequency interference as well as against the indirect effects of lightning strikes.

**1.3 Recommended fields of application**

Stationary measurements in water/wastewater applications in Class I Division 2 hazardous locations.

The VARiON<sup>®Plus</sup> 700 IQ H sensor is a sensor for the online determination of ammonium ions and/or nitrate ions in water / waste water applications. It supplements D. O. measurement in the aeration tank of waste water treatment plants and enables an efficient process control of nitrogen removal.



More detailed information on measuring with ion sensitive electrodes is given in the primer, ION SELECTIVE MEASUREMENT IN ONLINE ANALYSIS.







## 2 Safety

### 2.1 Safety information

#### 2.1.1 Hazard warnings in this operating manual

This operating manual provides important information on the safe operation of the product. Read this operating manual thoroughly and make yourself familiar with the product before putting it into operation or working with it. The operating manual must be kept in the vicinity of the product so you can always find the information you need.

The hazard warnings are defined for the following levels of danger:

	<p style="text-align: center;"><b>⚠ DANGER</b></p> <p>DANGER indicates an imminently hazardous situation which, if not avoided, will result in death or serious injury.</p>
	<p style="text-align: center;"><b>⚠ WARNING</b></p> <p>WARNING indicates a potentially hazardous situation which, if not avoided, could result in death or serious injury.</p>
	<p style="text-align: center;"><b>⚠ CAUTION</b></p> <p>CAUTION indicates a potentially hazardous situation which, if not avoided, may result in minor or moderate injury.</p>
	<p style="text-align: center;"><b>NOTICE</b></p> <p>NOTICE is used to address practices not related to personal injury.</p>

#### 2.1.2 Safety information on the product

Note all labels, information signs and safety symbols on the product.

#### 2.1.3 Further documents providing safety information

The following documents provide additional information, which you should observe for your safety when working with the measuring sys-

tem:

- Operating manuals of other components of the measuring system (power packs, controller, accessories)
- Safety datasheets of calibration and maintenance equipment (e.g. cleaning solutions).

## 2.2 Safe operation

### 2.2.1 Authorized use

The authorized use of the VARiON<sup>®Plus</sup> 700 IQ H consists of its use as a sensor in the IQ SENSORNET. Only the operation and running of the sensor according to the instructions and technical specifications given in this operating manual is authorized (see chapter 9 TECHNICAL DATA). Any other use is considered unauthorized.

### 2.2.2 Requirements for safe operation

Note the following points for safe operation:



- The product may only be operated according to the authorized use specified above.
- The product may only be supplied with power by the energy sources mentioned in this operating manual.
- The product may only be operated under the environmental conditions mentioned in this operating manual.
- The product may not be opened.

### 2.2.3 Unauthorized use

The product must not be put into operation if:

- it is visibly damaged (e.g. after being transported)
- it was stored under adverse conditions for a lengthy period of time (storing conditions, see chapter 9 TECHNICAL DATA).

### 2.3 Hazardous location use

	 <b>DANGER</b>
	<p><b>Explosion hazard.</b>  <b>Only hazardous location rated sensor models ("Hazloc Sensor") must be used in hazardous locations. Read the name plate on the sensor shaft and verify that the sensor is rated for your specific application.</b></p>

**Rated sensor models**



The following sensor models is rated for hazardous location use:

VARiON<sup>®Plus</sup> 700 IQ H (YSI-Order No. 207040Y)

Hazardous location rated sensors are identified by the name plate with the rating details engraved on the sensor shaft:

**Name plate of a Hazloc sensor (example)**

	
<p>VARiON<sup>®</sup> Plus 700 IQ H                  Hazloc Sensor                  Rated: Class I Division 2 Groups A, B, C, D, T6                  Class I Zone 2 Group IIC T6                  0°C ≤ Ta ≤ +40°C                  = 14...24 V DC/ 0,2 W                  Control Drawing NO 28123</p>	<p>Intertek                  2001759                  CONFORMS TO                  UL 61010-1                  UL 121201                  CERTIFIED TO                  CAN/CSA C22.2 # 61010-1                  CAN/CSA C22.2 # 213</p>

	 <b>DANGER</b>
	<p><b>Explosion hazard.</b>  <b>The associated apparatus MIQ/BB1 (YSI part no. 207001Y) has to be used for connection. Refer to the following documents for proper installation:</b></p> <ul style="list-style-type: none"> <li>● <b>Control drawing, YSI document no. 28123 (see MIQ/BB1 operating manual)</b></li> <li>● <b>MIQ/BB1 operating manual</b></li> <li>● <b>All applicable electrical code regulations.</b></li> </ul>

	 <b>DANGER</b>
	<p><b>Explosion hazard.</b>  <b>This product does not meet the requirements of the directive 94/9/EC (ATEX).</b></p>

## 3 Commissioning

### 3.1 Scopes of delivery

The VARiON<sup>®Plus</sup> 700 IQ H sensor is provided in sets for different measurement requirements. Each set contains the following components:

- Unequipped sensor VARiON<sup>®Plus</sup> 700 IQ H. The electrode receptacles are closed with blind plugs
- Reference electrode VARiON<sup>®Plus</sup> Ref
- Depending on the set, the suitable selection from the following measurement and compensation electrodes:
  - VARiON<sup>®Plus</sup> NH4 (ammonium electrode)
  - VARiON<sup>®Plus</sup> K (potassium electrode for compensation)
  - VARiON<sup>®Plus</sup> NO3 (nitrate electrode)
  - VARiON<sup>®Plus</sup> Cl (chloride electrode for compensation)
- Special socket wrench
- VARiON<sup>®</sup> 700 IQ-SK protective hood
- Potassium chloride solution for storing the reference electrode
- Operating manual



Information on the available sets is given in the YSI catalog and on the Internet.

### 3.2 Notes on the handling of the electrodes

The electrodes of the VARiON<sup>®Plus</sup> 700 IQ H sensor were developed for the rough use in waste water treatment plants. They are, however, precision parts that can be damaged by inappropriate use.

#### 3.2.1 Effects to be generally avoided

Avoid the following effects that can adversely affect the measurement characteristics of the electrodes or reduce their lifetime:

- Drying-up of the electrode membrane and junction
- Scratching of the electrode membrane and junction
- Contact with fat, oil, alcohol, acids, lyes, tensides and similar substances

- Cleaning with washing-up liquid (tenside!)
- Cleaning with or storing in deionized water
- Storing in wrong storing solution

Therefore, exactly follow the instructions in the two following chapters.

### 3.2.2 Reference electrode

#### Commissioning

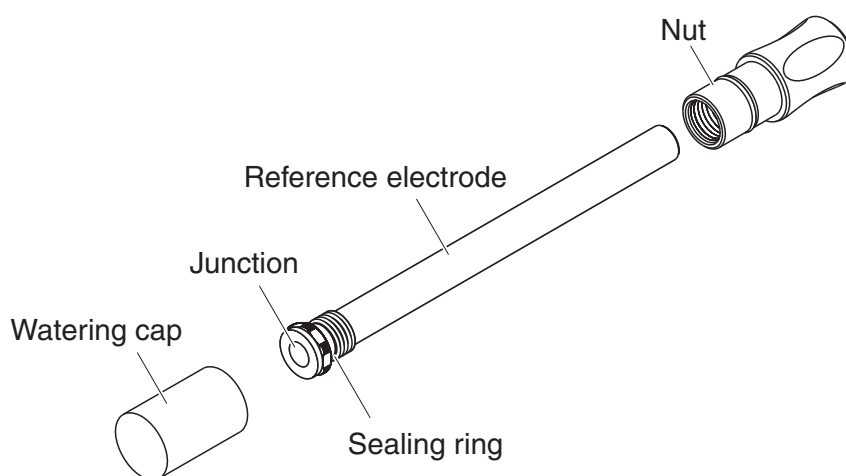

Fig. 3-1 Reference electrode with storing aids

In the delivery condition, the electrode is equipped with a watering cap and a nut that protects the screw-in thread. The watering cap contains 3 mol/l potassium chloride solution. Before mounting, unscrew the watering cap. Then, using the special hexagon key, unscrew the electrode from the nut. Keep both storing aids in case you want to store the electrode.



The junction of the reference electrode must not

- dry up (follow notes on storage)
- be damaged
- be brought into contact with grease.

#### Notes on storage

If you will not use the electrode for a longer period of time, screw the electrode into the nut as far as it will go. Fill the watering cap to the brim with 3 mol/l potassium chloride solution and tightly screw the watering cap on the electrode by hand.

### 3.2.3 Measurement electrodes and compensation electrodes

#### Commissioning

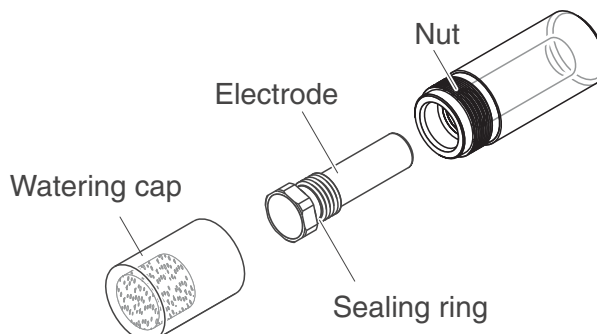

Fig. 3-2 Measurement or compensation electrode with storing aids

In the delivery condition, each electrode is equipped with a watering cap and a nut that protects the screw-in thread. Prior to installation, first remove the watering cap and, using the special hexagon key, unscrew the electrode from the nut. Keep both storing aids in case you want to store the electrode.



The membrane of the electrode must not

- dry up (follow notes on storage)
- be damaged
- be brought into contact with grease.

#### Notes on storage

If you will not use the electrode for a longer period of time, screw the electrode into the nut as far as it will go. Soak the foam insert in the watering cap with VARiON®/ES-1 standard solution (lower concentration) and plug the electrode into the watering cap.



#### NOTICE

Make sure to use the correct solution for the watering cap (VARiON®/ES -1 standard solution). If you use the watering solution of the reference electrode instead the function of the electrode can be seriously damaged.

### 3.3 Getting the sensor ready for measuring

#### 3.3.1 Equipping the sensor with electrodes

<b>NOTICE</b>	
	The sensor can be damaged by dirt and moisture. Before mounting the electrodes make sure the area behind the sealing ring of the electrodes and the receptacle are dry and clean. The VARiON <sup>®Plus</sup> 700 IQ H may only be submersed when the electrodes or original blind plugs are mounted.



More detailed information on the electrode equipment for the various operating modes is given in chapter 1.2.

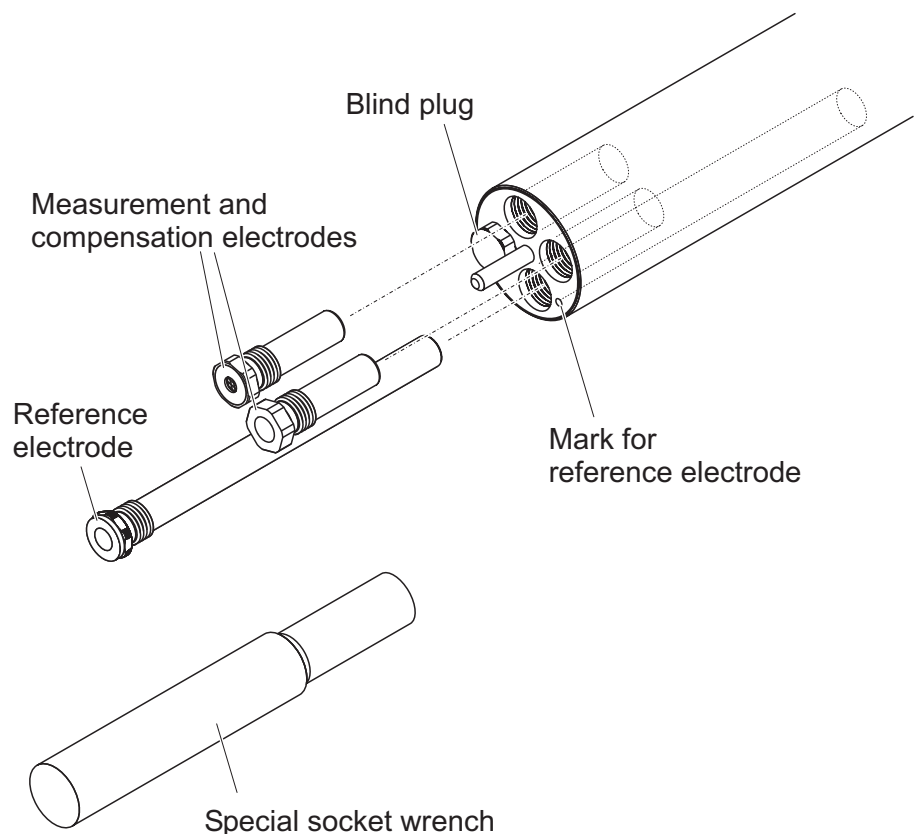

Fig. 3-3 Equipping the sensor with electrodes.

All receptacles are closed with blind plugs in the delivery condition. Screw the electrodes into the receptacles instead of the blind plugs.

When doing so observe the following points:

- The receptacle for the reference electrode is marked by a recess. It extends into the inside of the sensor clearly deeper than the other three receptacles (see Fig. 3-3).
- The measurement and compensation electrodes can be mounted in the remaining three receptacles in any order.
- During installation make sure the area behind the sealing ring of the electrode and the receptacle are absolutely dry and clean.
- Plug the electrode on the special socket wrench provided and insert the electrode with the special socket wrench.
- Screw until the electrode is seated on the electrode support without any gap. Thus the tightness and electrical contacting are granted.



When mounted, the electrodes can be recognized by the features described in section 6.3.

### **CH cleaning head (option)**

#### **3.3.2 Mounting the protective hood**

For permanent operation, we recommend to use the CH cleaning head for compressed air-driven cleaning. It is mounted instead of the standard protective hood. The compressed air cleaning is started time-controlled via the IQ SENSORNET system. Information on the required components is given in the catalog and on the Internet.

If no CH cleaning head is used the standard protective hood should always be mounted for measuring. It protects the electrodes from rough mechanical impact.



### Mounting the standard protective hood

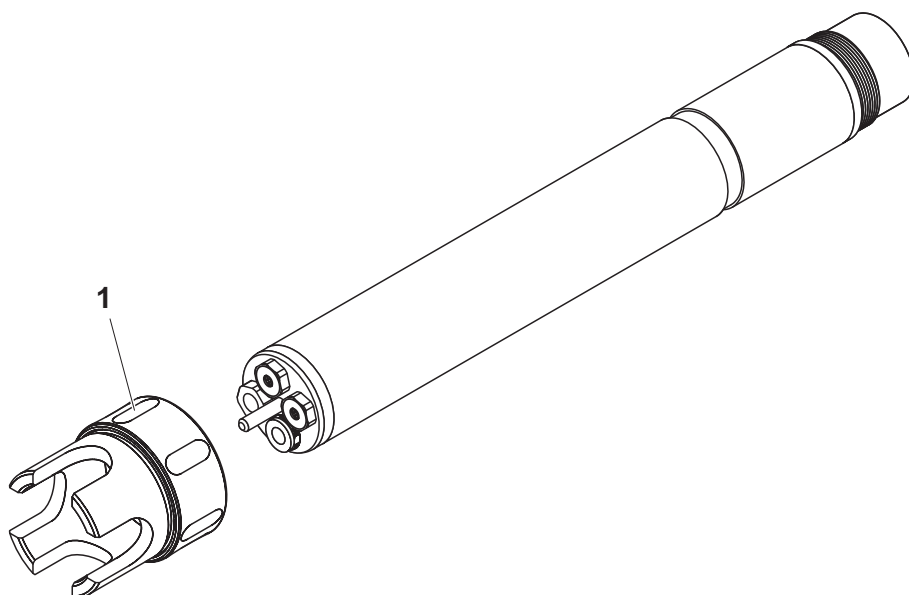

Fig. 3-4 Mounting the standard protective hood.



- 1 Loosen the coupling ring (1) of the protective hood.
- 2 Push the protective hood on the sensor as far as it will go.
- 3 Tighten the coupling ring of the protective hood.

### Cleaning the protective hood

The coupling ring of the protective hood can be taken apart for cleaning purposes (see section 6.2 EXTERIOR CLEANING).

### 3.3.3 Connecting the sensor to the IQ SENSORNET

**Safety guidelines for installation in a hazardous location**

	<b> DANGER</b>
	<p><b>Explosion hazard.</b>  <b>Only hazardous location rated sensor models ("Hazloc Sensor") must be used in hazardous locations. Verify the rating on the product name plate on the sensor shaft.</b>  <b>The associated apparatus MIQ/BB1 (YSI part no. 207001Y) has to be used for connection. Refer to the following documents for proper installation:</b></p> <ul style="list-style-type: none"> <li>● <b>Control drawing, YSI document no. 28123 (see MIQ/BB1 operating manual)</b></li> <li>● <b>MIQ/BB1 operating manual</b></li> <li>● <b>All applicable electrical code regulations.</b></li> </ul>

**Connection cable**

A sensor connection cable of the SACIQ type is required to connect the sensor. The cable is available in different lengths.

	<b> DANGER</b>
	<p><b>Explosion hazard.</b>  <b>For hazardous location use only the cable types listed in the control drawing must be used.</b></p>



How to connect the SACIQ sensor connection cable to the terminal strip of a MIQ module is described in chapter 3 INSTALLATION of the IQ SENSORNET system operating manual.

**Are the plug connections dry?**

Before connecting the sensor and sensor connection cable, please make sure the plug connections are dry. If moisture gets into the plug connections, first dry the plug connections (dab them dry or blow them dry using compressed air).



Do not suspend the sensor on the sensor connection cable. Use a sensor holder or armature. Information on this and other IQ SENSORNET accessories is given in the YSI catalog and on the Internet.

### Connecting the sensor to the sensor connection cable

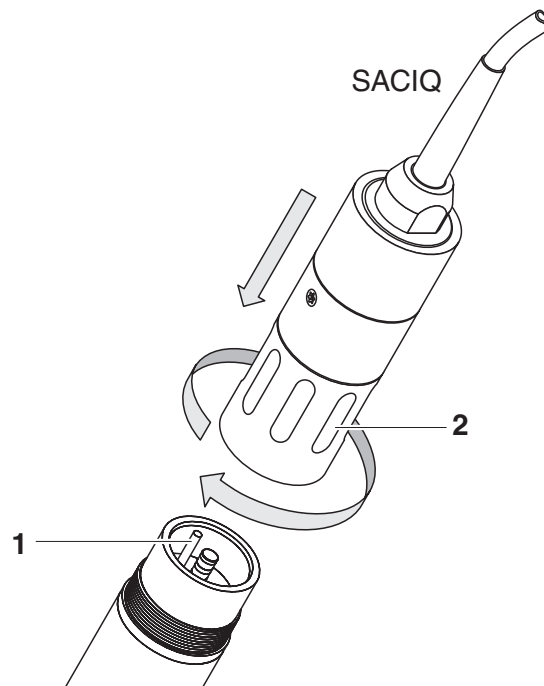

Fig. 3-5 Connect the sensor

- 1 Take the protective caps off the plug connections of the sensor and the SACIQ sensor connection cable, and keep them safe.
- 2 Plug the socket of the SACIQ sensor connection cable onto the plug head connector of the sensor. At the same time, rotate the socket so that the pin in the plug head connector (1) clicks into one of the two holes in the socket.
- 3 Then screw the coupling ring (2) of the sensor connection cable onto the sensor up to the stop.

### 3.4 Settings

#### 3.4.1 General information

##### Automatic electrode recognition

The VARiON<sup>®Plus</sup> 700 IQ H software automatically recognizes the built-in electrodes and checks the equipment for validity. Depending on the equipment, the following sensors can be displayed in the list of sensors:

sensor	Designation
VARiON <sup>®Plus</sup> 700 IQ H Ammonium sensor	VARiON A
VARiON <sup>®Plus</sup> 700 IQ H Nitrate sensor	VARiON N
VARiON <sup>®Plus</sup> 700 IQ H potassium sensor *	VARiON K
VARiON <sup>®Plus</sup> 700 IQ H chloride sensor *	VARiON Cl

\* see setting table of the sensor

##### Sensor overlapping settings

Certain settings are sensor overlapping and can be made in any one of the setting tables. The setting is used by all sensors.

The sensor overlapping settings are:

- *Temperature mode (°C/°F)*
- *Temp. adjustment*

##### Carrying out settings

Using **<S>**, switch from the measured value display to the main menu of the settings. Then navigate to the setting menu (setting table) of the sensor. The exact procedure is given in the relevant IQ SENSORNET system operating manual.

The setting tables of the sensors are described in the following chapters.

## 3.4.2 Setting table VARiON A (ammonium sensor)

Menu item	Selection/Values	Explanations
<i>Measuring mode</i>	<ul style="list-style-type: none"> <li>● <i>NH4-N</i></li> <li>● <i>NH4</i></li> <li>● <i>mV</i></li> </ul>	Citation form of the mass concentration or voltage of the electrode.
<i>Measuring range</i> ( <i>Measuring mode: NH4-N</i> )	<ul style="list-style-type: none"> <li>● <i>AutoRange</i></li> <li>● <i>0.1 ... 100.0 mg/l</i></li> <li>● <i>1 ... 2000 mg/l</i></li> </ul>	2 measuring ranges can be selected. With <i>AutoRange</i> , the instrument automatically switches to the suitable measuring range.
<i>Measuring range</i> ( <i>Measuring mode: NH4</i> )	<ul style="list-style-type: none"> <li>● <i>AutoRange</i></li> <li>● <i>0.1 ... 129.0 mg/l</i></li> <li>● <i>1 ... 2580 mg/l</i></li> </ul>	2 measuring ranges can be selected. With <i>AutoRange</i> , the instrument automatically switches to the suitable measuring range.
<i>Measuring range</i> ( <i>Measuring mode: mV</i> )	<ul style="list-style-type: none"> <li>● <i>-2000 ... 2000 mV</i></li> </ul>	Fixed range

If the sensor is not equipped with a potassium electrode:

<i>Potassium compens.</i>	<i>Manual</i>	<p>After determining the potassium content of the test solution, enter the potassium content determined in the next line manually (<i>Potassium conc.</i>). The measured value is accordingly corrected by the entered potassium content.</p> <p><b>Note:</b> With the <i>Link (sensor to sensor)</i> function, the IQ SENSORNET is able to provide a measured value for the interfering ion.</p> <p><b>Note:</b> Detailed information on the subject of potassium compensation is given in the primer, ION SELECTIVE MEASUREMENT IN ONLINE ANALYSIS.</p>
<i>Potassium conc.</i>	<i>0.1 ... 1000 mg/l</i>	Manual input of the potassium value

Menu item	Selection/Values	Explanations
If the sensor is equipped with a potassium electrode:		
<i>VARiON K</i>	<ul style="list-style-type: none"> <li>● <i>hide</i></li> <li>● <i>show</i></li> </ul>	<p><i>hide</i> (standard setting): The potassium electrode is not displayed as an extra sensor in the measured value display. More settings are possible (see below). <i>show</i>: If the sensor is equipped with the potassium electrode, the electrode is displayed as the extra sensor <i>VARiON K</i> in the measured value display. The relevant settings can be done in an extra setting table (see section 3.4.4). <u>Note</u>: If the maximum number of sensors for the system is exceeded by activating the sensor, the <i>VARiON K</i> cannot be activated.</p>
If the setting <i>VARiON K hide</i> was additionally selected:		
<i>Calib. history K</i>	<ul style="list-style-type: none"> <li>● <i>Do not download</i></li> <li>● <i>Transmit to log book</i></li> </ul>	The selection of <i>Transmit to log book</i> generates a log book message with the calibration history of the potassium electrode. When opening the setting table again the setting is reset to <i>Do not download</i> .
<i>Potassium compens.</i>	<i>Automatic</i>	When the potassium electrode is mounted, the potassium compensation takes places automatically only. The value of the potassium concentration measured at the time the setting table was opened is displayed in the next line ( <i>Potassium conc.</i> ).
<i>Potassium conc.</i>		Display of the measured potassium value ( <i>0.1 ... 1000 mg/l</i> ).
<i>Temperature mode</i> (only with <i>Measuring mode: NH4-N or NH4</i> )	<ul style="list-style-type: none"> <li>● °C</li> <li>● °F</li> </ul>	Unit of the measured temperature value (Celsius, Fahrenheit).

Menu item	Selection/Values	Explanations
<i>Temp. adjustment</i> (only with <i>Measuring mode: NH4-N</i> or <i>NH4</i> )	-1.5 °C ... +1.5 °C	The temperature compensation function enables the temperature sensor to be balanced against a reference temperature measurement (displacement of the zero point by ±1.5 °C). Notes: <ul style="list-style-type: none"> <li>● Due to the thermal capacity of the sensor, it is necessary to place it in a container with at least 2 liters of water.</li> <li>● Leave the sensor in this container for at least 15 minutes while stirring occasionally, then carry out the adjustment. If the temperature difference of the water and sensor is &gt; 10°C, leave the sensor in the container for at least one hour while stirring occasionally.</li> </ul>
<i>Conc. offset</i>	-1.0 mg/l ... +1.0 mg/l	Constant value that is added to the measured value.
<i>Save and quit</i>		The system confirms the saving of the settings and the display switches to the next higher level.
<i>Quit</i>		The display switches to the next higher level without storing the new settings.

### 3.4.3 Setting table VARiON N (nitrate sensor)

Menu item	Selection/Values	Explanations
<i>Measuring mode</i>	<ul style="list-style-type: none"> <li>● <i>NO3-N</i></li> <li>● <i>NO3</i></li> <li>● <i>mV</i></li> </ul>	Citation form of the mass concentration or voltage of the electrode.
<i>Measuring range</i> ( <i>Measuring mode: NO3-N</i> )	<ul style="list-style-type: none"> <li>● <i>AutoRange</i></li> <li>● <i>0.1 ... 100.0 mg/l</i></li> <li>● <i>1 ... 1000 mg/l</i></li> </ul>	2 measuring ranges can be selected. With <i>AutoRange</i> , the instrument automatically switches to the suitable measuring range.
<i>Measuring range</i> ( <i>Measuring mode: NO3</i> )	<ul style="list-style-type: none"> <li>● <i>AutoRange</i></li> <li>● <i>0.5 ... 450.0 mg/l</i></li> <li>● <i>5 ... 4500 mg/l</i></li> </ul>	2 measuring ranges can be selected. With <i>AutoRange</i> , the instrument automatically switches to the suitable measuring range.

Menu item	Selection/Values	Explanations
<i>Measuring range</i> ( <i>Measuring mode: mV</i> )	● -2000 ... 2000 mV	Fixed range
If the sensor is <u>not</u> equipped with a chloride electrode:		
<i>Chloride compens.</i>	<i>Manual</i>	After determining the chloride content of the test solution enter the chloride content determined in the next line manually ( <i>Chloride conc.</i> ). The measured value is accordingly corrected by the entered chloride content. <u>Note:</u> With the <i>Link (sensor to sensor)</i> function, the IQ SENSORNET is able to provide a measured value for the interfering ion. <u>Note:</u> Detailed information on the subject of chloride compensation is given in the primer, ION SELECTIVE MEASUREMENT IN ONLINE ANALYSIS.
<i>Chloride conc.</i>	<i>0.1 ... 1000 mg/l</i>	Manual input of the chloride value
If the sensor is equipped with a chloride electrode:		
<i>VARiON Cl</i>	<ul style="list-style-type: none"> <li>● <i>hide</i></li> <li>● <i>show</i></li> </ul>	<p><i>hide</i> (standard setting): The chloride electrode is not displayed as an extra sensor in the measured value display.</p> <p><i>show:</i> If the sensor is equipped with the chloride electrode, the electrode is displayed as the extra sensor <i>VARiON Cl</i> in the measured value display. The relevant settings can be done in an extra setting table (see section 3.4.5). <u>Note:</u> If the maximum number of sensors for the system is exceeded by activating the sensor, the <i>VARiON Cl</i> cannot be activated.</p>



Menu item	Selection/Values	Explanations
If the setting <i>VARiON CI hide</i> was additionally selected:		
<i>Calib. history CI</i>	<ul style="list-style-type: none"> <li>● <i>Do not download</i></li> <li>● <i>Transmit to log book</i></li> </ul>	The selection of <i>Transmit to log book</i> generates a log book message with the calibration history of the potassium electrode. When opening the setting table again the setting is reset to <i>Do not download</i> .
<i>Chloride compens.</i>	<i>Automatic</i>	When a chloride electrode is mounted, the chloride compensation takes places automatically only. The value of the chloride concentration measured at the time the setting table was opened is displayed in the next line ( <i>Chloride conc.</i> ).
<i>Chloride conc.</i>		Display of the measured chloride value (0.1 ... 1000 mg/l).
<i>Temperature mode</i> (only with <i>Measuring mode: NO3-N or NO3</i> )	<ul style="list-style-type: none"> <li>● °C</li> <li>● °F</li> </ul>	Unit of the measured temperature value (Celsius, Fahrenheit).
<i>Temp. adjustment</i> (only with <i>Measuring mode: NO3-N or NO3</i> )	-1.5 °C ... +1.5 °C	The temperature compensation function enables the temperature sensor to be balanced against a reference temperature measurement (displacement of the zero point by ±1.5 °C). Notes: <ul style="list-style-type: none"> <li>● Due to the thermal capacity of the sensor, it is necessary to place it in a container with at least 2 liters of water.</li> <li>● Leave the sensor in this container for at least 15 minutes while stirring occasionally, then carry out the adjustment. If the temperature difference of the water and sensor is &gt; 10°C, leave the sensor in the container for at least one hour while stirring occasionally.</li> </ul>
<i>Conc. offset</i>	-1.0 mg/l ... +1.0 mg/l	Constant value that is added to the measured value.
<i>Save and quit</i>		The system confirms the saving of the settings and the display switches to the next higher level.
<i>Quit</i>		The display switches to the next higher level without storing the new settings.

### 3.4.4 Setting table VARiON K (potassium sensor)



These sensor settings are only available if in the sensor settings for the VARiON A the setting VARiON K was set to *Active* (see section 3.4.2).

The basic settings are taken over from the VARiON A sensor but can be adjusted separately afterwards.

Menu item	Selection/Values	Explanations
<i>Measuring mode</i>	<ul style="list-style-type: none"> <li>● <i>K (mg/l)</i></li> <li>● <i>mV</i></li> </ul>	Citation form of the mass concentration or voltage of the electrode.
<i>Measuring range</i> <i>Measuring mode:</i> <i>K (mg/l)</i>	<ul style="list-style-type: none"> <li>● <i>AutoRange</i></li> <li>● <i>0.1 ... 100.0 mg/l</i></li> <li>● <i>1 ... 1000 mg/l</i></li> </ul>	Fixed range
<i>Measuring range</i> <i>Measuring mode:</i> <i>mV</i>	<ul style="list-style-type: none"> <li>● <i>-2000 ... 2000 mV</i></li> </ul>	Fixed range
<i>Temperature mode</i> (only with <i>Measuring mode:</i> <i>K (mg/l)</i> )	<ul style="list-style-type: none"> <li>● <i>°C</i></li> <li>● <i>°F</i></li> </ul>	Unit of the measured temperature value (Celsius, Fahrenheit).
<i>Temp. adjustment</i> (only with <i>Measuring mode:</i> <i>K (mg/l)</i> )	<i>-1.5 °C ... +1.5 °C</i>	<p>The temperature compensation function enables the temperature sensor to be balanced against a reference temperature measurement (displacement of the zero point by <math>\pm 1.5</math> °C).</p> <p>Notes:</p> <ul style="list-style-type: none"> <li>● Due to the thermal capacity of the sensor, it is necessary to place it in a container with at least 2 liters of water.</li> <li>● Leave the sensor in this container for at least 15 minutes while stirring occasionally, then carry out the adjustment. If the temperature difference of the water and sensor is <math>&gt; 10</math> °C, leave the sensor in the container for at least one hour while stirring occasionally.</li> </ul>
<i>Conc. offset</i>	<i>-10.0 mg/l ... +10. mg/l</i>	Constant value that is added to the measured value.
<i>Save and quit</i>		The system confirms the saving of the settings and the display switches to the next higher level.

Menu item	Selection/Values	Explanations
<i>Quit</i>		The display switches to the next higher level without storing the new settings.

### 3.4.5 Setting table VARiON Cl (chloride sensor)



These sensor settings are only available if in the sensor settings for the VARiON N the setting VARiON Cl was set to *Active* (see section 3.4.3).

The basic settings are taken over from the VARiON N sensor but can be adjusted separately afterwards.

Menu item	Selection/Values	Explanations
<i>Measuring mode</i>	<ul style="list-style-type: none"> <li>● <i>Cl (mg/l)</i></li> <li>● <i>mV</i></li> </ul>	Citation form of the mass concentration or voltage of the electrode.
<i>Measuring range</i> <i>Measuring mode:</i> <i>Cl (mg/l)</i>	<ul style="list-style-type: none"> <li>● <i>AutoRange</i></li> <li>● <i>0.1 ... 100.0 mg/l</i></li> <li>● <i>1 ... 1000 mg/l</i></li> </ul>	Fixed range
<i>Measuring range</i> <i>Measuring mode:</i> <i>mV</i>	<ul style="list-style-type: none"> <li>● <i>-2000 ... 2000 mV</i></li> </ul>	Fixed range
<i>Temperature mode</i> (only with <i>Measuring mode:</i> <i>Cl (mg/l)</i> )	<ul style="list-style-type: none"> <li>● <i>°C</i></li> <li>● <i>°F</i></li> </ul>	Unit of the measured temperature value (Celsius, Fahrenheit).

Menu item	Selection/Values	Explanations
<i>Temp. adjustment</i> (only with <i>Measuring mode: Cl (mg/l)</i> )	-1.5 °C ... +1.5 °C	The temperature compensation function enables the temperature sensor to be balanced against a reference temperature measurement (displacement of the zero point by $\pm 1.5$ °C). Notes: <ul style="list-style-type: none"> <li>● Due to the thermal capacity of the sensor, it is necessary to place it in a container with at least 2 liters of water.</li> <li>● Leave the sensor in this container for at least 15 minutes while stirring occasionally, then carry out the adjustment. If the temperature difference of the water and sensor is <math>&gt; 10</math> °C, leave the sensor in the container for at least one hour while stirring occasionally.</li> </ul>
<i>Conc. offset</i>	-10.0 mg/l ... +10. mg/l	Constant value that is added to the measured value.
<i>Save and quit</i>		The system confirms the saving of the settings and the display switches to the next higher level.
<i>Quit</i>		The display switches to the next higher level without storing the new settings.

## 4 Matrix adjustment, check and calibration

### 4.1 General information

#### Calibration free operation

The VARiON<sup>®Plus</sup> 700 IQ H sensor is immediately ready to measure after being equipped with electrodes. For precise measurements, it is only necessary to adjust the electrodes to the sample matrix ("matrix adjustment"). In the recommended application (see section 1.3 RECOMMENDED FIELDS OF APPLICATION), the measuring characteristics of the electrodes remain stable for their entire service life. Thus, calibration is not recommended.

Possible changes of the sample matrix can be determined by occasional comparison measurements (e.g. photometer) and compensated for by a new matrix adjustment as necessary. The sensor does not have to be taken out of the sample for this. At the same time, a matrix adjustment provides information on the state of the electrodes.

#### Drift potential:

Simultaneously with the matrix adjustment (or calibration), the drift voltage DV(mV) of the electrode is determined. It serves to evaluate the long-term behavior of the electrode. The drift voltage changes due to the following factors:

- Influences due to the sample composition (matrix)
- Changes of the electrode characteristic(s).

#### Zeroing

The temporal change of the drift voltage is recorded in the calibration history so the long-term behavior of a electrode can be evaluated. As a start value, the user has to set the drift voltage to zero (zeroing) at the beginning of this evaluation period in order to observe any changes in the calibration history.

The zeroing for an electrode is done within the *MATRIX ADJUSTMENT* or *CALIBRATION* procedure if the zeroing was selected for the electrode (checked off). It becomes effective if the procedure was successfully carried out.

Carry out the zeroing when commissioning the electrode so you can watch in the calibration history the entire working period of the electrode.

It is not possible to zero an electrode with the *CHECK* procedure, as this procedure stores no data in the sensor.

#### Resetting the slope with the zeroing

Zeroing with the *MATRIX ADJUSTMENT* procedure resets the slope to the default setting (+ or - 59.2 mV) at the same time. Zeroing with the *CALIBRATION* procedure replaces the existing slope with the newly determined value.

## 4.2 Matrix adjustment

### 4.2.1 General information on matrix adjustment

This procedure adjusts the value measured directly in the test sample to an independently determined reference value ("lab value"). To determine the reference values, a sample is taken from the measuring solution and the relevant concentrations are measured (e.g. photometrically).

First select for which of the installed electrodes the matrix adjustment should be carried out. Based on this selection and the electrode equipment, the sensor software determines the ion types for which a reference measurement must be carried out. The menu guided routine adapts itself correspondingly and informs you of all necessary actions.

### 4.2.2 Carrying out the matrix adjustment



Prior to the matrix adjustment, check the chloride electrode for coatings and polish it as necessary (see section 6.4).

#### Main steps

- Step 1:** Determination of all electrode voltages ("reference voltages"). The sensor is in the sample. The procedure is started from the measured value display with **<C>**. After completion the system returns to the measured value display.
- Step 2:** Sampling at the same place and time if possible and determination of all relevant reference values
- Step 3:** Entry and storage of the measured reference values. This step is started by pressing **<C>** again.

#### Online help

A convenient, menu guided routine guides you through the *MATRIX ADJUSTMENT* procedure. In addition, you can call up an *Online help* with **<C>** for each step. An info box with detailed information on the relevant operating step appears on the display. It provides, for example, important instructions on how to keep the correct basic conditions. When **<OK>** is pressed, the display returns to the current operating step.

#### Matrix adjustment with zeroing

After installing a new or different electrode you have to zero the electrode to facilitate a long-term evaluation. Details on zeroing, see section 4.1.

#### Practical instructions

- Ammonium and nitrate have to be determined immediately after taking the sample as their content changes very quickly due to the micro organisms that are present. It is best to take the sample imme-

diately using a syringe filter for transport to the laboratory or to stabilize it otherwise. When adding stabilizing solutions, the dilution factor has to be taken into account.

- When determining the reference concentrations in the lab (step 2), you can use the sensor for control purposes at the same time. The sensor continues to use the data of the previous matrix adjustment (or calibration). The reference voltages determined in step 1 will not be lost. They remain stored until step 3 of the matrix adjustment is completed. They do not have to be noted and entered again.
- Use the *Online help* if you are unsure of anything during the matrix adjustment.

#### 4.2.3 Result of the matrix adjustment

##### Evaluation

After the matrix adjustment, the system automatically evaluates the current condition of the electrode(s) based on the drift voltage. For a successful matrix adjustment, the drift voltage must be within the range -45 mV to +45 mV. The drift voltage is set to 0 mV if you have selected a zeroing.

At the end of the matrix adjustment procedure the drift voltage of all selected electrodes is shown on the display. The evaluation is indicated with a check mark (✓ = successful) or a minus sign ("-" = not successful).

##### Taking over the determined values

For each successfully adjusted electrode you can individually decide whether the values should be stored for measurement.



If the matrix adjustment was erroneous due to an incorrect determination or entry of the reference concentration, you can correct the entry (if necessary several times). If, by doing so, it is not possible to eliminate the error, the complete matrix adjustment for this electrode has to be repeated or discarded. If it is discarded, measurement is continued with the values of the last valid matrix adjustment (or calibration). Values of successfully adjusted electrodes that were already stored are retained.



Actions for error elimination are given in the *Online help* and in chapter 8 WHAT TO DO IF ....

##### Sensor history

The data of the matrix adjustment are available in the *Sensor history* (see section 4.4 SENSOR HISTORY).

#### 4.2.4 Special functions

The simple matrix adjustment, as described in the sections 4.2.2 to 4.2.3, will in most cases lead to precise measurement results. In some cases, special effects in the matrix can cause the real characteristic curve of the ISE measurement to deviate from the factory characteristic curve. This can lead to measured values that are not precise enough.

After consultation with the service department, it is possible to provide special functions to adjust the sensor for use in a special sample matrix or special measurement conditions.

These special functions can be selected like the other procedures.

### 4.3 Check and calibration in standard solutions

#### 4.3.1 General information on checking and calibrating

In addition to the comparison measurement or matrix adjustment under real measurement conditions, it is possible to check the function of the entire sensor in standard solutions. If necessary, you can also take over in the sensor the slope and potential level of the individual electrodes via an exact calibration in standard solutions. The slope will be retained with a future matrix adjustment if it is carried out without zeroing the electrode.



The long term stable VARiON<sup>®Plus</sup> electrodes are calibration-free in the recommended application. A check in standard solutions is only of significance if all basic conditions (cleanness, conditioning etc.) are strictly kept.

Calibrating the sensor is neither necessary nor recommended.

Calibration can cause major measurement errors if the basic conditions are not sufficiently kept. After calibrating, a matrix adjustment in the sample is required in addition. Standard solutions do not correspond to any real test sample!

#### When does a check or calibration make sense?

A check or calibration can be useful in the following special cases:

- If the measured values do not appear to be correct even after a careful matrix adjustment and if you suspect the electrode slopes to have changed
- If a new application is to be started whose sample composition considerably deviates from that of the recommended application (see section 1.3 RECOMMENDED FIELDS OF APPLICATION)
- Routinely within the framework of the company quality assurance



### Differences between *CHECK* and *CALIBRATION*

The check and calibration are carried out in two separate routines. The schema is the same with both routines: Two standard solutions with different concentrations are measured one after the other. The procedures *CHECK* and *CALIBRATION* differ as follows:

- *CHECK*:

The basic conditions to be kept are less strict. It is suitable as a quick method to check whether the slope and potential level of the electrodes are within the allowed limits. The results are just for information. No characteristics or sensor settings are changed.

- *CALIBRATION*:

For this procedure, the basic conditions must comply with very high requirements (longer conditioning times, discarding of the conditioning solution, temperature adjustment etc.). Correspondingly, it requires more time. The slope and drift voltage are exactly determined and evaluated. If the calibration was successful, the determined values can be taken over for measurement. The procedure can, however, be used as a mere check method. Calibration is documented in the calibration history and in the log book.



Calibration is neither necessary nor recommended for the sensor.

### Standard solutions

For the procedures *CHECK* or *CALIBRATION*, the following standard solutions in the following order:

- VARiON<sup>®</sup>/ES-2 (high concentration)
- VARiON<sup>®</sup>/ES-1 (low concentration).

These standard solutions contain all ion types that come into question (ammonium, nitrate, potassium, chloride) and are especially adapted to the VARiON<sup>®Plus</sup> 700 IQ H.

### Online help

A comfortable, menu guided routine guides you through the procedure. In addition, you can call up an *Online help* with <C> for each step. An info box with detailed information on the relevant operating step appears on the display. It provides, for example, important instructions on how to keep the correct basic conditions. When <OK> is pressed, the display returns to the current operating step.

### Calibration with zeroing

After installing a new or different electrode you have to zero the electrode to facilitate a long-term evaluation. Details on zeroing, see section 4.1.



A chloride electrode should be checked for coatings and polished off as necessary before the check or calibration is carried out (see section 6.4).

**Preparations and instructions on how to keep the basic conditions**

- Select a place where clean working conditions and a constant, sufficiently high temperature are granted (a room, e.g. laboratory). Temperatures under 10 °C extend the conditioning time considerably.
- Make sure the temperature of all components (sensor, standard solutions, containers, accessories etc.) is similar and constant. We recommend to store the standard solutions in the same place where the check or calibration is carried out.
- Use containers and accessories (beaker, stirring rod) that are absolutely clean and without detergent residues. Detergent residues can seriously affect the function of the electrodes.
- Remove the protective hood and clean the sensor thoroughly. Before the check, rinse the sensor with standard solution VARiON<sup>®</sup>/ES-2.
- Make sure the depth of immersion is sufficient (minimum 5 cm).
- Make sure there are no air bubbles in front of the electrode membrane.
- Conditioning times: During the conditioning steps, all relevant electrode voltages are indicated on the display. Thus you can observe the conditioning process.
- Regular stirring accelerates the conditioning process considerably. Stirring with a stirring rod or the sensor itself is sufficient.
- For calibration, the standard solution is discarded after conditioning. This is pointed out by a corresponding note in the calibration routine. It is essential for an exact calibration result.
- Use the *Online help* if you are unsure of anything during calibration.

**4.3.2 Result of the check****Evaluation**

At the end of the check, the result for the electrodes is shown on the display with "+" (successful) or "-" (unsuccessful). The exact check criteria are given in the *Online help* of the result display. At the same time the result is entered in the log book as an info message. There is no entry in the calibration history.

**Sensor history**

The result of the check is available in the *Sensor history* (see section 4.4 SENSOR HISTORY).

**4.3.3 Result of the calibration****Evaluation**

With calibration, the system automatically evaluates the condition of an electrode based on the data of its characteristic curve. The drift potential and slope are evaluated separately. For a calibration procedure to

be valid, the potential level, slope and drift voltage must be within certain ranges.

Valid ranges for slope and drift potential:

Value of the slope: 50 ... 70 mV

Drift voltage: -45 ... +45 mV

The valid potential levels (MIN, MAX) can be taken from the online help.

### Taking over the determined values

For each successfully calibrated electrode you can individually decide whether the values should be stored for measurement.



Actions for error elimination are given in chapter 8 WHAT TO DO IF ....

### Sensor history

The result of the calibration is available in the *Sensor history* (see section 4.4 SENSOR HISTORY).

## 4.4 Sensor history

The data of the calibration procedures and matrix adjustments are available in the Sensor history and in the calibration history.

The sensor history supplements and expands the calibration history:

- The results of any checks are displayed.
- All data of all electrodes of the sensor can be displayed in one list.
- More datasets can be displayed for each electrode.

### Sensor history

- 1 In the measured value display, select the sensor with <▲▼> and use <C> to open the *PROCEDURE/SETTINGS* window for the sensor.
- 2 Select the menu *Sensor history*.
- 3 Select the electrodes that should be displayed in the *Sensor history*.
- 4 Follow the user guide.  
The *Sensor history* is displayed for the selected electrodes.



Using <S>, you can save the displayed Sensor history to a USB memory device connected (directory, VARiON).

- Calibration history**
- 1 In the measured value display, select the sensor with <▲▼> and confirm with <OK>. The *Anzeige/Optionen* menu pops up.
  - 2 Display the individual calibration histories.

MIQ/T2020	05 Apr 2006 12 28			⚠ ⚠ ⚠		
Calibration history of selected sensor 330						
SO1 VARiON A		04460001				
Date	S	DV	Ref1	Ref2	K+ P	T R
24.11.05	58.7	0	ES2	ES1	ES2 3 21	+
05.04.06	58.4*	13	2.6	-	11 1 15	+
27.02.06	58.4	1	ES2	ES1	ES2 3 22	+
16.01.06	58.7*	16	4.7	-	15 1 7	+
25.11.05	58.7*	14	4.0	-	18 1 10	+
Return ESC						

Last zeroing (here, by calibration)

Chronological list with the last matrix adjustments and calibrations

Fig. 4-1 Calibration history with matrix adjustments (example: VARiON A)

The calibration history provides the following information:

<b>Date</b>	Date of the calibration or matrix adjustment
<b>S</b>	Slope [mV] of the electrode. <u>Note:</u> After a matrix adjustment, the values for the slope are marked by a star (*) because they were not changed by this procedure.
<b>DV</b>	Drift voltage [mV] After zeroing and subsequent calibration or matrix adjustment, 0 is displayed.
<b>Ref1/Ref2</b>	Depending on the procedure. Matrix adjustment: Reference concentration [mg/l] Calibration: Standard solution used (ES1, ES2)
<b>K+, Cl-</b>	Depending on the procedure. Matrix adjustment: Interfering ions concentration [mg/l] Calibration: Standard solution, VARiON <sup>®</sup> /ES-2
<b>P</b>	Procedure (1 = matrix adjustment, 3 = calibration)
<b>T</b>	Temperature [°C]
<b>R</b>	Evaluation of the calibration or matrix adjustment + : Calibration or matrix adjustment. The sensor measures with the new calibration or adjustment data. ? : Calibration or matrix adjustment not accepted and not saved. Measurement is continued with the last valid values.





If the compensation electrode is displayed as an extra sensor, the calibration history of the compensation electrode can be viewed in the sensor menu of this sensor.

Log book messages are displayed with the main sensor. The IQ SENSORNET does not keep an extra log book for this sensor.

If the compensation electrode is not displayed as an extra sensor, you can, if required, generate a log book message with the calibration history via the menu item *Calib. history CI (or Calib. history K)* in the setting table of the relevant main sensor. The log book message is in the log book of the relevant main sensor (VARiON A -> message code IC5395, VARiON N -> message code IC6396).

## 5 Measuring

### 5.1 Measurement operation

	 <b>WARNING</b>
	<p><b>Chemical or biological hazard.</b>  <b>Contact with the sample can be harmful to the user.</b>  <b>Depending on the type of sample, suitable protective measures must be taken (protective clothing, goggles, etc.).</b></p>

Note the data given in section 9.2 APPLICATION CONDITIONS, especially the minimum immersion depth of the sensor (> 50 mm with mounted protective hood).

	<b>NOTICE</b>
	<p>Greases, oils, certain tensides and similar substances can shorten the operational lifetime of the electrodes. Therefore, they should not be present in the test sample (see section 3.2.1 EFFECTS TO BE GENERALLY AVOIDED).</p>



If necessary, the CH Cleaning head can be used to keep the sensor clean (see chapter 7 REPLACEMENT PARTS AND ACCESSORIES).

### 5.2 Factors affecting the measured value

For measurement with the VARiON<sup>®Plus</sup> 700 IQ H the following influencing variables can be important, depending on the measured parameter:



Measured parameter	Influencing variable
Ammonium	<ul style="list-style-type: none"> <li>● pH value</li> <li>● Potassium ions</li> </ul>
Nitrate	<ul style="list-style-type: none"> <li>● Chloride ions</li> </ul>



The effects of influencing variables on measurement and compensating actions are described in detail in the primer ION SELECTIVE MEASUREMENT IN ONLINE ANALYSIS.

## 6 Maintenance and electrode exchange

### 6.1 General maintenance instructions

	 <b>WARNING</b>
	<p><b>Chemical or biological hazard.</b>  <b>Contact with the sample can be harmful to the user.</b>  <b>Depending on the type of sample, suitable protective measures must be taken (protective clothing, goggles, etc.).</b></p>

#### Maintenance condition

We recommend to switch on the maintenance condition each time the sensor is taken out of the measuring position. This avoids unwanted reactions of linked outputs. More detailed information on the maintenance condition is given in the respective IQ SENSORNET system operating manual.

#### VARiON<sup>®</sup>/Epack

The VARiON<sup>®</sup>/Epack set with usual replacement parts is available for maintenance (see chapter 7 REPLACEMENT PARTS AND ACCESSORIES).

### 6.2 Exterior cleaning



To keep the electrodes clean, we recommend to use the CH cleaning head (see chapter 7 REPLACEMENT PARTS AND ACCESSORIES).

With normal operation (e.g. municipal wastewater) we strongly recommend to clean the outside of the sensor:

- when it is strongly contaminated (after visual check)
- if erroneous measured values are suspected
- each time before removing or exchanging an electrode

	<b>NOTICE</b>
	<p>Do not use any detergent or deionized water for cleaning. Heed the notes in section 3.2.1 EFFECTS TO BE GENERALLY AVOIDED.</p>



We recommend to clean the sensor shaft and electrodes while the sensor is still connected to the sensor connection cable. Otherwise, moisture and/or dirt can get into the plug connection where it can cause contact problems.

If you need to disconnect the sensor from the sensor connection cable, please note the following points:

- Before disconnecting the sensor from the SACIQ sensor connection cable, remove any larger pieces of contamination from the sensor, particularly in the area of the plug connection (brush it off in a bucket of tap water, wash it off with a hose or wipe it off with a cloth).
- Unscrew the sensor from the SACIQ sensor connection cable.
- Always place a protective cap on the plug head of the sensor and on the SACIQ sensor connection cable so that no moisture or dirt can get into the contacting surfaces.
- In corrosive environments, close the socket of the sensor connection cable with the screwable SACIQ-Plug when it is dry in order to protect the electrical contacts from corrosion. The protective plug is available as an accessory (see section 7.2 GENERAL ACCESSORIES).

**Cleaning the sensor**

Clean the sensor shaft with tap water and a soft sponge or brush. Remove the protective hood. The electrodes are best cleaned under running tap water using a soft toothbrush or brush.

**Cleaning the coupling ring of the protective hood**

The coupling ring can be unscrewed and dismantled for cleaning as follows:

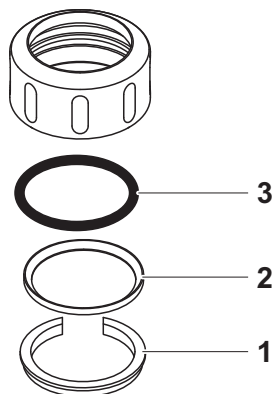



Fig. 6-1 Dismantling the coupling ring

- 1 Remove the retaining ring (pos. 1 in Fig. 6-1).
- 2 Remove the intermediate ring (pos. 2) and sealing ring (pos. 3).



After the parts have been cleaned, reassemble the coupling ring in reverse order. When doing so make sure that the tapered side of the intermediate ring (pos. 2) points towards the sealing ring (pos. 3).





### 6.3 Exchanging the electrodes

	<b>NOTICE</b>
	<p>The sensor can be damaged by dirt and moisture. Each time before dismantling an electrode carefully clean the area around the electrodes (section 6.2). Before mounting an electrode make sure the area behind the sealing ring of the electrode and the receptacle are dry and clean. The VARiON®Plus 700 IQ H may only be submersed when the electrodes or original blind plugs are mounted.</p>

Use the special socket wrench provided to dismantle an electrode. Electrodes are installed as described in section 3.3.1 EQUIPPING THE SENSOR WITH ELECTRODES.

#### Recognizing the electrode type from outside

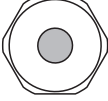
When mounted, the electrodes can be recognized by the following features:

Electrode	Hexagon	Front surface	Other features
VARiON®Plus Ref 	black	black	– Thread at the hexagon
VARiON®Plus NH4 	black	black	– Hexagon without thread
VARiON®Plus K 	black	white	
VARiON®Plus NO3 	white	white	– Labeled with the electrode type
VARiON®Plus Cl 	black	black	– Larger membrane – Membrane flush with the front surface



For the correct storage of the electrodes please follow the instructions in section 3.2 NOTES ON THE HANDLING OF THE ELECTRODES.

## 6.4 Polishing the chloride electrode

Caused by the test medium, a coating can develop on the surface of the chloride electrode, which gradually reduces the electrode slope. To maintain a proper chloride compensation the surface must be renewed by polishing at regular intervals.

	<b>NOTICE</b>
	Danger of damaging the electrode. Exclusively use the SF 300 polishing strip. Never use commercial sandpaper or similar..

The polishing can be done while the electrode is mounted (remove the protective hood as necessary). For polishing, exclusively use the SF 300 polishing strip included in the scope of delivery of the chloride electrode (see chapter 7 REPLACEMENT PARTS AND ACCESSORIES). Moisten the rough side of the polishing strip with water and polish off any coatings under slight pressure.

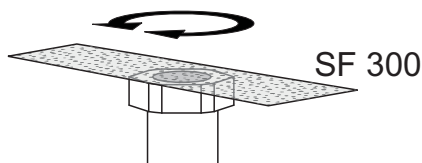

Fig. 6-2 Polishing the chloride electrode.

## 7 Replacement parts and accessories

### 7.1 Electrodes

#### Exchange electrodes

Description	Model	Order no.
Reference electrode	VARiON®Plus Ref	107042
Ammonium electrode	VARiON®Plus NH4	107044
Nitrate electrode	VARiON®Plus NO3	107045
Potassium electrode	VARiON®Plus K	107046
Chloride electrode	VARiON®Plus Cl	107047

#### Storing equipment

Description	Model	Order no.
250 ml potassium chloride solution for storing the reference electrode	KCl-250	109705

### 7.2 General accessories

#### Standard solutions for calibration

Description	Model	Order no.
1 liter combination standard 1 (low concentration)	VARiON®/ES-1	107050
1 liter combination standard 2 (high concentration)	VARiON®/ES-2	107052

#### Maintenance equipment

Description	Model	Order no.
Polishing strip	SF 300	203680

#### Protective plugs

Description	Model	Order no.
Screwable plug for sensor connection cable	SACIQ-Plug	480065

**General replacement parts**

Description	Model	Order no.
Protective hood	VARiON <sup>®</sup> 700 IQ-SK	107056
Replacement parts set, comprising <ul style="list-style-type: none"> <li>– 1 blind plug for receptacle</li> <li>– 1 special socket wrench</li> <li>– 3 replacement sealing rings for electrodes/blind plugs</li> <li>– Storing equipment for electrodes: <ul style="list-style-type: none"> <li>1 nut (transparent),</li> <li>1 watering cap with sponge</li> <li>1 nut (black)</li> <li>1 watering cap (without sponge) for reference electrode</li> </ul> </li> </ul>	VARiON <sup>®</sup> /Epack	107057

**Components for cleaning system**

Description	Model	Order no.
Cleaning head	CH	900107
Passive valve module	DIQ/CHV	472007
Active valve module (does not require a free relay output in the IQ SENSORNET system)	MIQ/CHV PLUS	480018
Air compressor supplying the sensor cleaning system with cleaning air	Cleaning Air Box 115 VAC 230 VAC	480017 480019



Information on further IQ SENSORNET accessories is given in the catalog and on the Internet.

## 8 What to do if ...

### 8.1 Interpretation of the drift voltage

The drift voltage is influenced by the potential levels of the measurement electrode and reference electrode. If the potential levels shift, e.g. caused by aging, both parts can move into the same direction or into opposite directions. The comparison of the drift voltages of two or three electrodes enables to draw conclusions concerning the state of individual electrodes if a matrix adjustment or calibration resulted in an invalid or considerably deviating drift voltage.

#### Assessment aids

View the calibration history of the electrodes. In the following cases, assessment is relatively easy:

- If the drift voltages of all electrodes show the same trend, i. e. the drift voltages have shifted in the same direction (positive or negative) by approximately the same amount, this indicates that the potential level of the reference electrode has shifted. The reference electrode is possibly highly contaminated or at the end of its service life.
- If the drift voltages of all electrodes do not show a trend but shift by different amounts into different directions, the potential level of the reference electrode has not changed considerably. The invalid drift voltage is probably caused by a defective measuring electrode. The measuring electrode is possibly highly contaminated or at the end of its service life.

## 8.2 Error causes and remedies

<b>No measured value display</b>	<b>Cause</b>	<b>Remedy</b>
	– Sensor not connected	– Connect the sensor
	– Incorrect electrode equipment	– Correct electrode equipment
	– Electrode(s) not at all or incorrectly recognized by the system	<ul style="list-style-type: none"> <li>– Check the installation and contacts of the electrode (gap-free mounting)</li> <li>– Check electrode receptacle for moisture</li> <li>– If necessary, unscrew the electrode/blind plug and thoroughly dry the electrode/blind plug and receptacle</li> </ul>
	– Unknown	– Look for error messages in the log book
	– Liquid in the sensor shaft	– Contact the service department
<b>Measurement provides implausible measured values</b>	<b>Cause</b>	<b>Remedy</b>
	– No matrix adjustment carried out	– Carry out matrix adjustment
	– Error during matrix adjustment (e.g. incorrect laboratory values)	<ul style="list-style-type: none"> <li>– Check the conditions of the matrix adjustment</li> <li>– Carry out new matrix adjustment</li> </ul>
	– Calibration error (e.g. contaminated standard solutions)	<ul style="list-style-type: none"> <li>– Check the calibration conditions</li> <li>– Recalibrate</li> <li>– Reset to default calibration</li> </ul>
	– Manual interfering ions compensation works with an unsuitable value	– Determine and enter the interfering ions compensation once again

Cause	Remedy
– Electrode(s) not at all or incorrectly recognized by the system	<ul style="list-style-type: none"> <li>– Check the installation and contacts of the electrode (gap-free mounting)</li> <li>– Check electrode receptacle for moisture</li> <li>– If necessary, unscrew the electrode/blind plug and thoroughly dry the electrode/blind plug and receptacle</li> </ul>
– Electrode contaminated	– Clean the electrode (see section 6.2)
– Liquid in the sensor shaft	– Contact the service department

**Measurement provides jumping, unstable or drifting values**

Cause	Remedy
– Measurement / compensation electrode: Electrode membrane not moistened by measuring solution, e.g. due to air in front of the membrane (membrane dried up)	– Moisten membrane with deionized water using a wash bottle. To do so, position the opening of the wash bottle on the membrane and splash against the membrane vigorously
– Measurement / compensation electrode: Air bubble behind the membrane	– Hold the electrode in a vertical position with the membrane down and knock it on the side with the special socket wrench until the air bubble moves up
– Measurement electrode / compensation and reference electrode: Insufficient electrical contact in the electrode receptacle	<ul style="list-style-type: none"> <li>– Check the installation and contacts of the electrode (gap-free mounting)</li> <li>– Check electrode receptacle for moisture</li> <li>– If necessary, unscrew the electrode/blind plug and thoroughly dry the electrode/blind plug and receptacle</li> </ul>
– Reference electrode dried up	– Replace reference electrode
– Measurement / compensation electrode or reference electrode leaky or damaged	– Replace defective electrode
– Liquid in the sensor shaft	– Contact the service department



**Faulty result of the matrix adjustment**

<b>Cause</b>	<b>Remedy</b>
<ul style="list-style-type: none"><li>– Error during procedure, e.g. incorrect lab values</li></ul>	<ul style="list-style-type: none"><li>– Check the basic conditions</li><li>– Follow the practical notes on page 30 or in the <i>online help</i></li><li>– Recalibrate</li></ul>
<ul style="list-style-type: none"><li>– Reference electrode or measurement electrode defective due to aging (see section 8.1)</li></ul>	<ul style="list-style-type: none"><li>– Replace defective electrode</li></ul>

**Faulty result of calibration**

<b>Cause</b>	<b>Remedy</b>
<ul style="list-style-type: none"><li>– Error during procedure, e.g. contaminated standard solutions</li></ul>	<ul style="list-style-type: none"><li>– Check the basic conditions</li><li>– Follow the practical notes on page 34 or in the <i>online help</i></li><li>– Recalibrate</li></ul>
<ul style="list-style-type: none"><li>– Reference electrode or measurement electrode defective due to aging (see section 8.1)</li></ul>	<ul style="list-style-type: none"><li>– Replace defective electrode</li></ul>

## 9 Technical data

### 9.1 Measuring characteristics

#### Measuring principle

Potentiometric measurement by means of ion sensitive electrodes. Modular structure with jointly used reference electrode and ion sensitive electrodes. Integrated microprocessor electronics, screened 2-wire connection for power and data transmission.

#### Measured parameters

Main measured parameters	Ammonium and/or nitrate (depending on the electrode equipment)
Secondary measured parameter	Temperature
Compensation parameters	Potassium or chloride (depending on the electrode equipment)

#### Measuring ranges and resolution, Ammonium measurement

Measuring mode	Measuring range	Resolution
NH4-N	0.1 ... 100.0 mg/l 1 ... 2000 mg/l	0.1 mg/L 1 mg/L
NH4	0.1 ... 129.0 mg/l 1 ... 2580 mg/l	0.1 mg/L 1 mg/L
mV	-2000 ... +2000 mV	1 mV

#### Measuring ranges and resolution, Nitrate measurement

Measuring mode	Measuring range	Resolution
NO3-N	0.1 ... 100.0 mg/l 1 ... 1000 mg/l	0.1 mg/L 1 mg/L
NO3	0.5 ... 450.0 mg/l 5 ... 4500 mg/l	0.5 mg/l 5 mg/l
mV	-2000 ... +2000 mV	1 mV

#### Measuring ranges and resolution, Potassium measurement

Measuring mode	Measuring range	Resolution
K	0.1 ... 100.0 mg/l 1 ... 1000 mg/l	0.1 mg/L 1 mg/L
mV	-2000 ... +2000 mV	1 mV

Measuring ranges and resolution, Chloride measurement	Measuring mode	Measuring range	Resolution
	Cl	0.1 ... 100.0 mg/l 1 ... 1000 mg/l	0.1 mg/L 1 mg/L
	mV	-2000 ... +2000 mV	1 mV

Interfering ions compensation	Main measured parameter	Interfering ions that can be compensated for
	Ammonium	Potassium (K <sup>+</sup> )
	Nitrate	Chloride (Cl <sup>-</sup> )

Selectable procedures for interfering ions compensation	Compensation procedures	Description
	Automatic	up to 1000 mg/l interfering ions when equipped with the corresponding compensation electrode
	Manual	without compensation electrode by manual entry of the interfering ions concentration (range 0.1 ... 1000 mg/l). <u>Note:</u> With the <i>Link (sensor to sensor)</i> function, the IQ SENSORNET is able to provide a measured value for the interfering ion.

Temperature measurement	Sensing element type	integrated NTC
	Measuring range	- 5 °C ... + 60 °C (23 ... 140 °F)
	Accuracy	± 0.5 K
	Resolution	0.1 K
	Response time t <sub>95</sub>	< 20 s

Temperature compensation	Automatic in the range 0 °C ... 40 °C (32 ... 104 °F)
--------------------------	---

### 9.2 Application conditions

<b>Allowed temperature range</b>	Measuring medium	0 °C ... 40 °C (32 ... 104 °F)
	Storage/transport	0 °C ... 40 °C (32 ... 104 °F)
<b>Allowed pH range of the measuring medium</b>	4 ... 12	
<b>Pressure resistance</b>	Sensor with the electrodes or blind plugs screwed in and the SACIQ sensor connection cable connected:	
<b>Type of protection</b>	Max. admissible overpressure	2 x 10 <sup>4</sup> Pa (0.2 bar)
	Sensor with the electrodes or blind plugs screwed in and the SACIQ sensor connection cable connected:	
	IP 68, 0.2 bar (2 x 10 <sup>4</sup> Pa)	
<b>Immersion depth</b>	min. 50 mm; max. 2 m depth	
<b>Operating position</b>	Electrode support pointing downward (maximum angle to the plumb line = 60 °)	
<b>Field of application</b>	<ul style="list-style-type: none"> <li>● Control / monitoring in the aeration tank of a waste water treatment plant</li> <li>● Water and waste water monitoring</li> </ul>	

### 9.3 General data

**Dimensions**

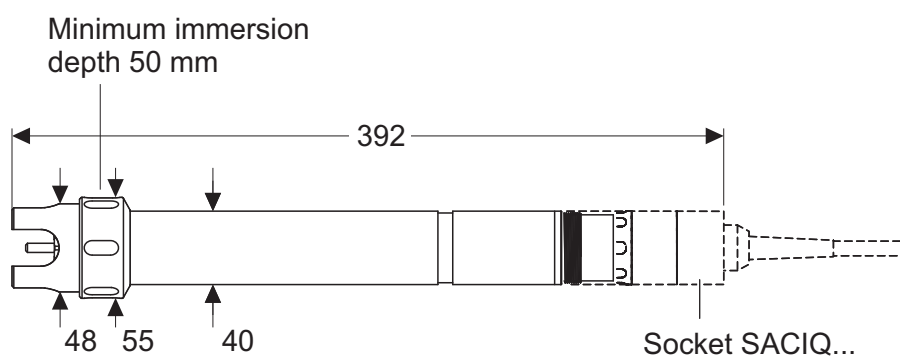

**Weight (without sensor connection cable)**

approx. 670 g with protective hood

**Connection technique** Connection via SACIQ sensor connection cable

<b>Material</b>		
Shaft		V4A stainless steel 1.4571
Protective hood		POM
Electrode support		POM
Temperature sensor		V4A stainless steel 1.4571
Plug head connector housing		POM
Plug, 3-pole		ETFE (blue) Tefzel <sup>®</sup>
Electrodes		see section 9.6



## NOTICE

Stainless steel can be sensitive to corrosion with chloride concentrations from  $\geq 500$  mg/l.

## 9.4 Instrument safety

### 9.4.1 General instrument safety

Applicable norms	<ul style="list-style-type: none"> <li>– UL 61010-1</li> <li>– CAN/CSA C22.2 # 61010.1</li> </ul>
------------------	---

### 9.4.2 Hazardous location ratings

#### Applicable directives and standards

In addition to the standards listed in chapter 9.4.1, the VARiON<sup>®Plus</sup> 700 IQ H conforms to the following directives and standards:

- UL 121201
- CAN/CSA C22.2 # 213

The VARiON<sup>®Plus</sup> 700 IQ H is a non-incendive electrical equipment for use in Class I Division 2 hazardous locations.

#### Hazardous location rating

Class I Division 2  
Groups A, B, C, D T6  
Class I Zone 2  
Groups IIC T6

Associated apparatus	MIQ/BB1, YSI part no. 207001Y
Control Drawing	YSI document no. 28123

## 9.5 Electrical data

Nominal voltage	Max. 24VDC via the IQ SENSORNET (for more details, see chapter TECHNICAL DATA of the IQ SENSORNET system operating manual)
Power consumption	0.2 W (with MIQ/BB1: 0.7 W)
Protective class	III

## 9.6 Data of the VARiON<sup>®Plus</sup> electrodes

### 9.6.1 Response times

	VARiON <sup>®Plus</sup> NH4	VARiON <sup>®Plus</sup> NO3	VARiON <sup>®Plus</sup> K	VARiON <sup>®Plus</sup> Cl
Response time $t_{90}$	< 3 min	< 3 min	< 3 min	< 3 min
Measured at 20 °C (68 °F) and a concentration change of ...	10 to 100 mg/l NH4-N	5 to 50 mg/l NO3-N	5 to 50 mg/l K	10 to 100 mg/l Cl

### 9.6.2 Materials

	VARiON <sup>®Plus</sup> NH4	VARiON <sup>®Plus</sup> NO3	VARiON <sup>®Plus</sup> K	VARiON <sup>®Plus</sup> Cl	VARiON <sup>®Plus</sup> Ref
--	-----------------------------	-----------------------------	---------------------------	----------------------------	-----------------------------

#### *Electrodes*

	VARiON <sup>®Plus</sup> NH4	VARiON <sup>®Plus</sup> NO3	VARiON <sup>®Plus</sup> K	VARiON <sup>®Plus</sup> Cl	VARiON <sup>®Plus</sup> Ref
Enclosure	POM	POM	POM	PVC	PVC
Clamping ring	POM	POM	POM	-	-
Membrane	soft PVC with stainless steel protective grating	soft PVC with stainless steel protective grating	soft PVC with stainless steel protective grating	ISE element (solid body) in epoxy	-
Junction	-	-	-	-	Porous PVDF
Sealing ring	FPM (Viton <sup>®</sup> )	FPM (Viton <sup>®</sup> )	FPM (Viton <sup>®</sup> )	FPM (Viton <sup>®</sup> )	FPM (Viton <sup>®</sup> )
Connection contacts	gold-plated	gold-plated	gold-plated	gold-plated	gold-plated

#### *Storing equipment*

	VARiON <sup>®Plus</sup> NH4	VARiON <sup>®Plus</sup> NO3	VARiON <sup>®Plus</sup> K	VARiON <sup>®Plus</sup> Cl	VARiON <sup>®Plus</sup> Ref
Watering cap	POM	POM	POM	POM	POM
Nut	PMMA	PMMA	PMMA	PMMA	POM

### 9.6.3 Weights

	VARiON <sup>®Plus</sup> NH4	VARiON <sup>®Plus</sup> NO3	VARiON <sup>®Plus</sup> K	VARiON <sup>®Plus</sup> Cl	VARiON <sup>®Plus</sup> Ref
	5 g	5 g	5 g	5 g	13 g

## 10 Indexes

### 10.1 Explanation of the messages

This chapter contains a list of all the message codes and related message texts that can occur in the log book of the IQ SENSORNET system for the VARiON<sup>®Plus</sup> 700 IQ H sensor.



Information on

- the contents and structure of the log book and
- the structure of the message code

is given in the LOG BOOK chapter of the IQ SENSORNET system operating manual.



The last three digits of the message code identify the source of the message:

- 521 = VARiON+700IQ (Armature / component class, adapters ADA)
- 395 = VARiON A (Ammonium / potassium electrode)
- 396 = VARiON N (Nitrate / chloride sensor)
- 397 = VARiON A (Potassium electrode)
- 398 = VARiON N (Nitrate sensor)

#### 10.1.1 Error messages

Message code	Message text
EA1395	<i>Meas. range exceeded or undercut</i> * Check process * Select other meas. range
EA1396	<i>Meas. range exceeded or undercut</i> * Check process * Select other meas. range
EA2521	<i>Sensor temperature too high!</i> * Check process and application
EA3521	<i>Sensor temperature too low!</i> * Check process and application
EAN395	<i>Potassium measurement: range exceeded or undercut</i> * Check process



<b>Message code</b>	<b>Message text</b>
EAO396	<i>Chloride measurement: range exceeded or undercut</i> <i>* Check process</i>
EIA521	<i>Incorrect equipment</i> <i>* for correct electrode equipment see operating manual</i>
ES1521	<i>Component hardware defective</i> <i>* Contact service</i>

### 10.1.2 Informative messages

<b>Message code</b>	<b>Message text</b>
IC3395	<i>K electrode has been successfully calibrated</i> <i>* For calibration data, see calibration history</i>
IC4396	<i>Cl electrode has been successfully calibrated</i> <i>* For calibration data, see calibration history</i>
IC5395	(This message contains calibration data of the potassium electrode)
IC6396	(This message contains calibration data of the chloride electrode)
IC7395 IC7396	<i>Sensor could not be calibrated,</i> <i>Measuring with old calibration values</i> <i>* Check calibration conditions and calibration standard</i> <i>* View calibration history</i> <i>* Service sensor immediately</i> <i>(see operating manual)</i>
ICA395ICA396	<i>Electrode: check successful</i>
ICB395	<i>K electrode: check successful</i>
ICC396	<i>Cl electrode: check successful</i>
ICD395ICD396	<i>Electrode: check unsuccessful</i> <i>Please follow online help.</i>
ICE395	<i>K electrode: check unsuccessful</i> <i>Please follow online help.</i>
ICF396	<i>Cl electrode: check unsuccessful</i> <i>Please follow online help.</i>
IIA521	(This message is generated when the electrode equipment is changed. It informs you of the new assignment of the electrode receptacles)
IAI397	<i>see VARiON A</i>
IAI398	<i>see VARiON N</i>

Message code	Message text
ICY395	VARiON A: Data of the last matrix adjustment or the last calibration
ICZ396	VARiON N: Data of the last matrix adjustment or the last calibration

## 10.2 Status info

The status info is a coded piece of information on the current status of a sensor. Each sensor sends this status info to the controller. The status info of sensors consists of 32 bits, each of which can have the value 0 or 1.

### Status info, general structure

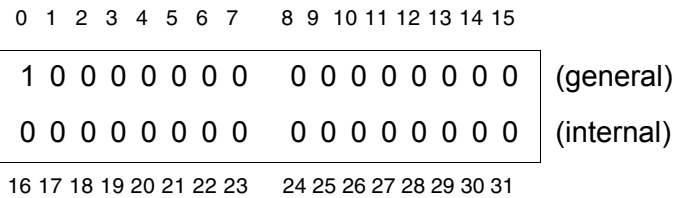

The bits 0 - 15 are reserved for general information.  
The bits 16 - 21 are reserved for internal service information.

You obtain the status info:

- via a manual query in the *Settings/Service/List of all components* menu (see system operating manual)
- by an automated query
  - from a superordinate process control (e. g. when connected to the Profibus)
  - of the IQ Data Server (see operating manual of the IQ SENSORNET software pack)



The evaluation of the status info, e.g. in the case of an automated query, has to be made individually for each bit.

### Status-Info VARiON®Plus 700 IQ H

Status bit	Explanation
Bit 0	Component hardware defective
Bit 1-31	-

## 11 Contact Information

### 11.1 Ordering & Technical Support

Telephone: (800) 897-4151  
(937) 767-7241  
Monday through Friday, 8:00 AM to 5:00 PM ET

Fax: (937) 767-1058

Email: [info@ysi.com](mailto:info@ysi.com)

Mail: YSI Incorporated  
1725 Brannum Lane  
Yellow Springs, OH 45387  
USA

Internet: [www.ysi.com](http://www.ysi.com)

When placing an order please have the following information available:

- YSI account number (if available)
- Model number or brief description
- Quantity
- Name and Phone Number
- Billing and shipping address
- Purchase Order or Credit Card

### 11.2 Service Information

YSI has authorized service centers throughout the United States and Internationally. For the nearest service center information, please visit [www.ysi.com](http://www.ysi.com) and click 'Support' or contact YSI Technical Support directly at 800-897-4151.

When returning a product for service, include the Product Return form with cleaning certification. The form must be completely filled out for an YSI Service Center to accept the instrument for service. The Product Return form may be downloaded at [www.ysi.com](http://www.ysi.com) and clicking on the 'Support' tab.





# Xylem |'zīləm|

- 1) The tissue in plants that brings water upward from the roots;
- 2) a leading global water technology company.

We're 12,500 people unified in a common purpose: creating innovative solutions to meet our world's water needs. Developing new technologies that will improve the way water is used, conserved, and re-used in the future is central to our work. We move, treat, analyze, and return water to the environment, and we help people use water efficiently, in their homes, buildings, factories and farms. In more than 150 countries, we have strong, long-standing relationships with customers who know us for our powerful combination of leading product brands and applications expertise, backed by a legacy of innovation.

**For more information on how Xylem can help you, go to [www.xylem.com](http://www.xylem.com)**



a **xylem** brand

YSI  
1725 Brannum Lane  
Yellow Springs, OH 45387  
Tel: +1 937-767-7241; 800-765-4974  
Fax: +1 937-767-1058  
Email: [info@ysi.com](mailto:info@ysi.com)  
Web: [www.ysi.com](http://www.ysi.com)

©Xylem Inc